

Contents

1 Product

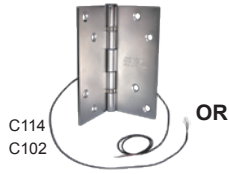

OR



2 User Guide

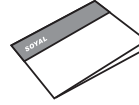

3 Specification

32AWG, 4-wire 12VDC / 320mA

Installation

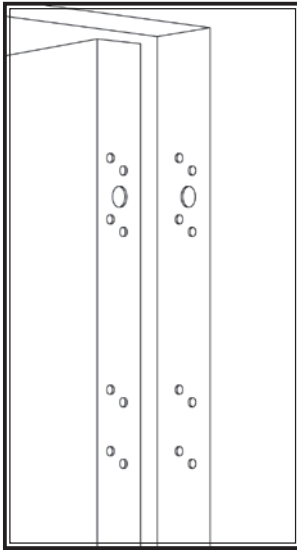

1 Make holes align to door fram and door jamb.

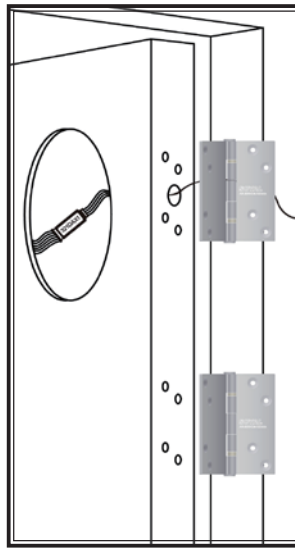

2 Connect wires to AR-321DAX1.

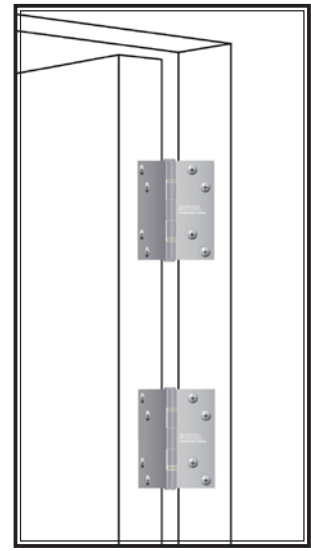

3 Fix the hinge with the supplied screws then apply power.

Dimensions

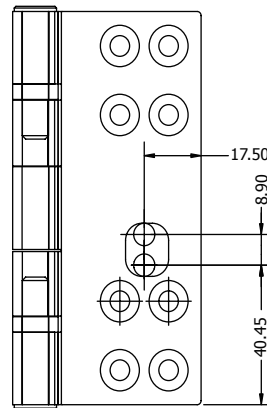
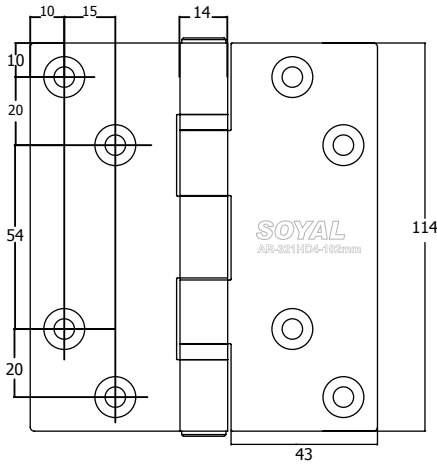

※ The figure to the right is the AR-321DH4C102 dimensional drawing

AR-321DH4

C114	4.5" x 4.5"	114mm x 114mm
C102	4.5" x 4"	114mm x 102mm
N114	4.5" x 4.5"	114mm x 114mm
N102	4.5" x 4"	114mm x 102mm

Wiring Diagram

