



T1220ML

rev.0213

Audio  
door entry system  
kits  
2 wires installation

**AS-1220 SII**



Instructions manual

Cod. 50124519

First of all we would like to thank and congratulate you for the purchase of this product.

The commitment to reach the satisfaction of our customers is stated through the ISO-9001 certification and for the manufacturing of products like this one.

Its advanced technology and exacting quality control will do that customers and users enjoy with the legion of features this system offers. To obtain the maximum profit of these features and a properly wired installation, we kindly recommend you to expend a few minutes of your time to read this manual.

## INDEX

Introduction .....	1	T-1772VD telephone.....	8
Index.....	1	Description.....	8
Starting recommendations .....	1	Function push buttons .....	8
System characteristics.....	2	Connection terminals.....	8
System operation .....	2	Call volume control .....	9
Door panel PES-1220 .....		JP2 configuration jumper.....	9
Description.....	3	Intercom function .....	9
Location.....	4 to 5	Fix the telephone .....	10
Wiring.....	5	Installation diagram .....	
JP2 configuration jumper.....	5	Connection to (1 apartment) .....	11
Final adjustments.....	5	Connection to (2 apartments).....	11
Push button label .....	6	Sections chart .....	12
Close the door panel.....	6	Connection a.c. lock release.....	12
Power supply FA-133 .....		Connection auxiliary device .....	12
Installation .....	7	Troubleshooting hints .....	13
Characteristics .....	7		
Lock release installation .....	7		

## STARTING RECOMMENDATIONS

- ☞ Do not use excessive force when tightening the power supply connection block screws.
- ☞ Install the equipment without the power connected.
- ☞ Before connecting the system, check the connections between door panel, telephone/s and the power supply connection.
- ☞ Only use compatible T-1772VD telephone.
- ☞ Only use parallel or twisted cable (to sections see page 40).
- ☞ Do not use single wire.
- ☞ Do not double the cable to increase the section.
- ☞ The entire installation must be at least 40 cm. away from any other installation otherwise there is a risk that the audio signal be exposed to interference, or that the system does not work correctly.
- ☞ Always use 12 Vd.c. lock releases (cod. 20600149, not included in the kit).
- ☞ Do not switch voltage higher than 12 Vd.c. / 1A between C and NO door panel terminals.
- ☞ Do always follow the enclosed information.

- ☞ Audio door entry system with simplified installation (polarised 2 wire bus).
- ☞ Up to 1 access door panel.
- ☞ Up to 2 apartments (Necessary setting configuration, see page 33 & 37 for door panel & telephone).
- ☞ Up to 4 telephones per installation.
- ☞ Installations with one apartment, maximum 4 telephones.
- ☞ Installations with two apartments, maximum 2 telephones per apartment.
- ☞ 'Long' acoustic call acknowledgment signals.
- ☞ 'Short' acoustic system busy signals (intercommunication).
- ☞ Maximum distance between the door panel and the last telephone: 100m.
- ☞ Maximum distance between power supply and telephone: 20m.
- ☞ Maximum distance between the door panel and lock release: 20m.
- ☞ Door opening timed at 3 seconds.
- ☞ D.C. lock release.
- ☞ Contact free auxiliary for activating auxiliary devices, do not switch voltage and current higher than 12Vcc/1A between C and NO door panel terminals.
- ☞ T-1772VD telephone:
  - ☞ Privacy on audio communications.
  - ☞ Intercommunication function.
  - ☞ Activation auxiliary device function.
  - ☞ Three-position control for call volume: maximum, medium and off.
  - ☞ Different call tones which identify the call procedure: door panel and intercom.

## SYSTEM OPERATION

- ☞ To make a call, the visitor should press over one of the push button ends, (if the door panel is configured for 2 apartments, each side of push button will call to an apartment) as it is shown on the label of the push button. An acoustic 'long' tone will be heard confirming the call is in progress once the push button has been pressed. At this moment, the call will be received at the telephone(s) in the apartment.
- ☞ If the door panel is configured for 2 apartments, the visitor can correct his call by pressing a push button corresponding to a different apartment, in which case the original call is cancelled.
- ☞ The call tone lasts for 40 seconds.
- ☞ To establish communication pick up the telephone handset.
- ☞ The communication will last for 90 seconds or until the handset is replaced.
- ☞ To open the door, press  the door release push button during communication process: with one press, the door release operates during 3 seconds.  
During activation, the audio will disappear with the door panel.
- ☞ The description of the function push buttons is shown on page 36.

## Door panel description PES-1220.

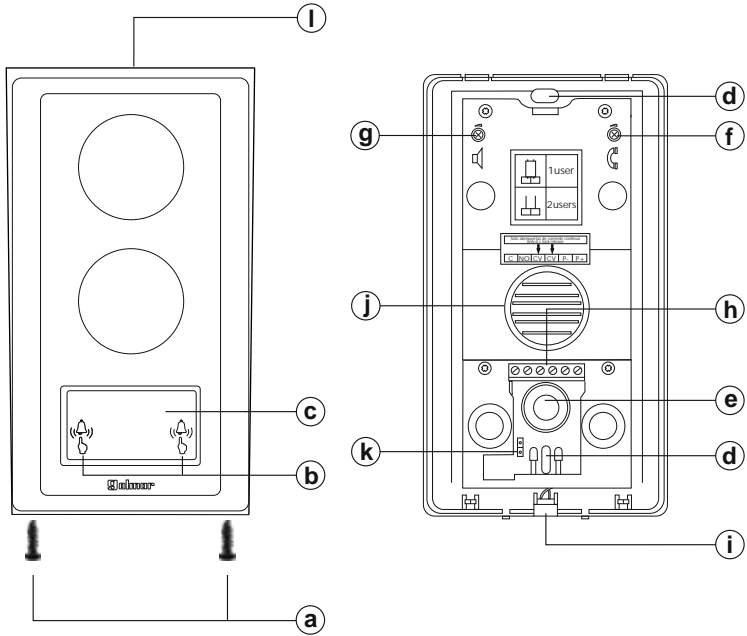

- a. Screws of fixation of the aluminium front (x2).
- b. Call push button for one or two apartments, (see page 39).
- c. Label push button.
- d. Wall attachment hook (x2).
- e. Wiring input hole.
- f. Telephone audio adjustment.
- g. Door panel audio adjustment.
- h. Installation terminals.
- i. Microphone.
- j. Speaker.
- k. JP2 configuration jumper for 1 or 2 apartments, (see page 33).
- l. Rainproof cover.

## D

oor panel positioning.

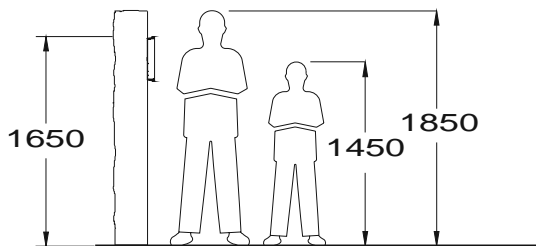

The upper part of the door panel should be placed at 1,65m. The surface door panel dimensions are the next:

W	96 mm.
H	181 mm.
D	20 mm.

The door panel has been designed to be placed under most of the environmental conditions. However it's recommended to take additional cautions, like the use of the supplied rainproof cover or the installation under a covered place.

## R

emove the aluminium front.

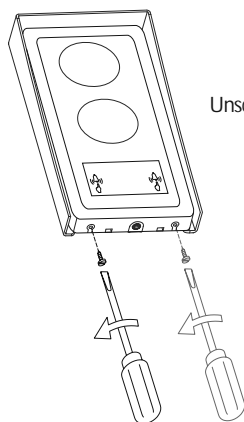

Unscrew the door panel bottom screws.

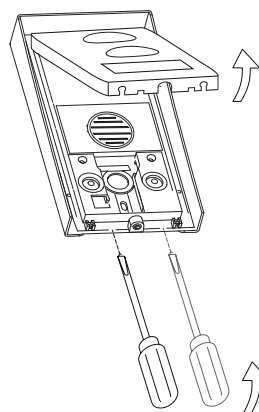

With help of a plain screwdriver, remove the aluminium front making a light pressure in the door panel bottom holes, as shown on the picture.

# DOOR PANEL INSTALLATION

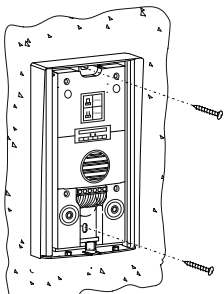

**P**lace the door panel.

Face the door panel to the wall by placing the top at 1,65m. height and insert the installation wires through the cables entry.

Drill two holes of 6mm. diameter and insert the wallplugs.  
Fix the door panel with especificated screws.

**D**oor panel wiring.

Connect the installation wires to the terminal connector, according to the installation diagrams.

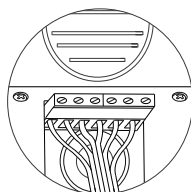

**C**onfiguration jumper 'JP2'.

The JP2 jumper is placed on the low left side of the door panel and it allows to select if the system is for 1 or 2 apartments.

\*JP2  System call to 1 apartment.

JP2  System call to 2 apartments.

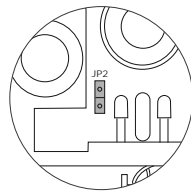



Call push button (1 apartment):

 Call to apartment 1.

 Call to apartment 1.

Call push button (2 apartments):

 Call to apartment 1.

 Call to apartment 2.

\*Factory default

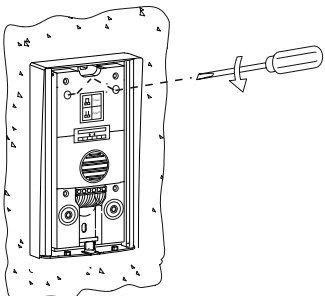

**F**inal adjustments.

If after starting the system it's considered that the audio volume isn't correct, proceed with the necessary adjustments as shown on the picture.

**P**ush button label.

To customize the push button label, insert a flat screwdriver to accede to the label, remove the push button front cover, see picture (A) & (B). The label is now accessible to mark a text, see picture (C).

Replace the push button front cover, making a light pressure until listening a click in both sides of the front cover, see picture (D).

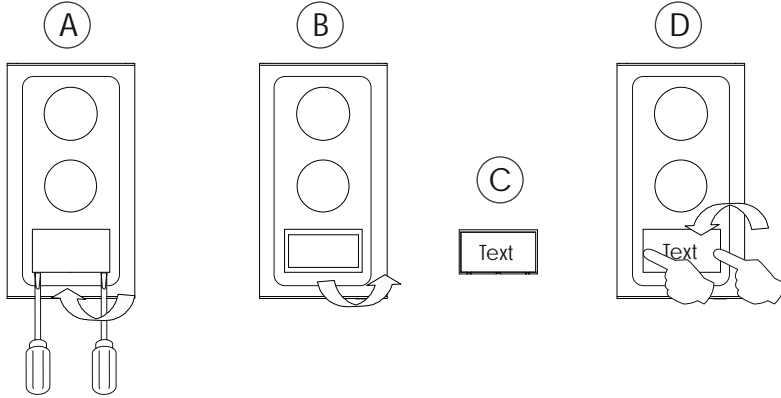

**C**lose the door panel.

Finish the door panel assembly by replacing the aluminium front.

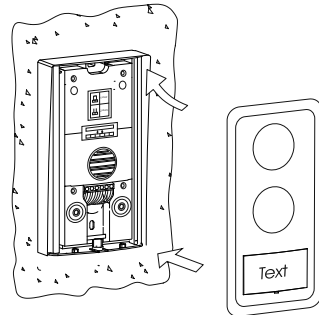
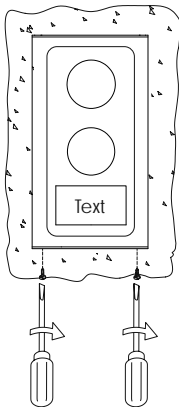

With help of a plain screwdriver, fix the aluminium front with especified screws, as shown on the picture.

**D**etail of the FA-133 power supply installation and technical features.

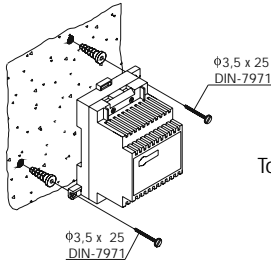

The power supply must be installed in a dry and protected place. It's recommended to protect the power supply by using a thermo-magnetic circuit breaker.

To install the power supply directly on the wall, drill two holes of Ø6mm. and insert the wallplugs. Fix the transformer with the specified screws.

The power supply can be installed on a DIN 46277 guide simply pressing it. To disassemble the power supply from the DIN guide, use a plain screwdriver to lever the flange as shown on the picture. The FA-133 power supply uses 3 units over DIN guide.

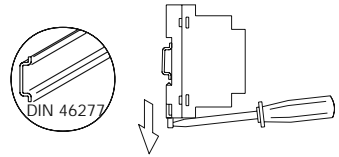

This device has been exclusively designed to be used on Golmar Kit audio AS-1220 SII. Golmar will not be responsible of the possible damage caused for an improper use or when used for other purposes than the specified. Install the power supply according to your country rules.

### Technical features

Input	230 Vac / 50 Hz
Power	9 VA
Output	18 Vdc 0,5A
Working temperature	-10°C ~ + 35°C
Dimensions	54(W) x 83(H) x 58(D) mm.
Weight	400 gr.

**IMPORTANT:** Replace the protection cover once the input terminals have been wired.

# LOCK RELEASE INSTALLATION

**L**ock release installation.

If the lock release will be installed in a metal door, use a Ø3,5mm. drill and tap the hole. In case of wood door, use a Ø3mm. drill.

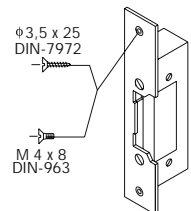

**IMPORTANT:**

The lock release must be 12V direct current, (see page 39).

Optionally lock release 12Vac with TF104 transformer and SAR-12/24 relay (see page 40).



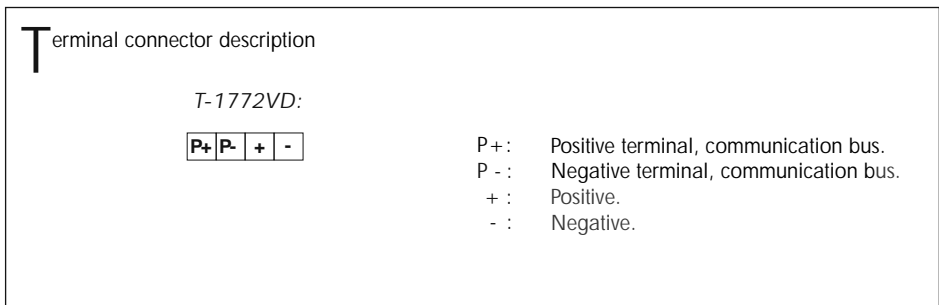
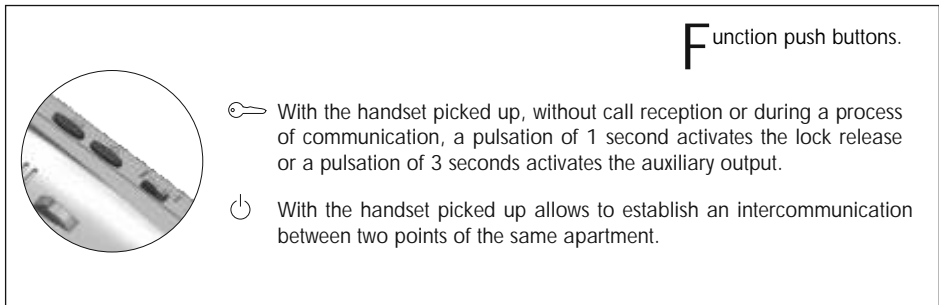
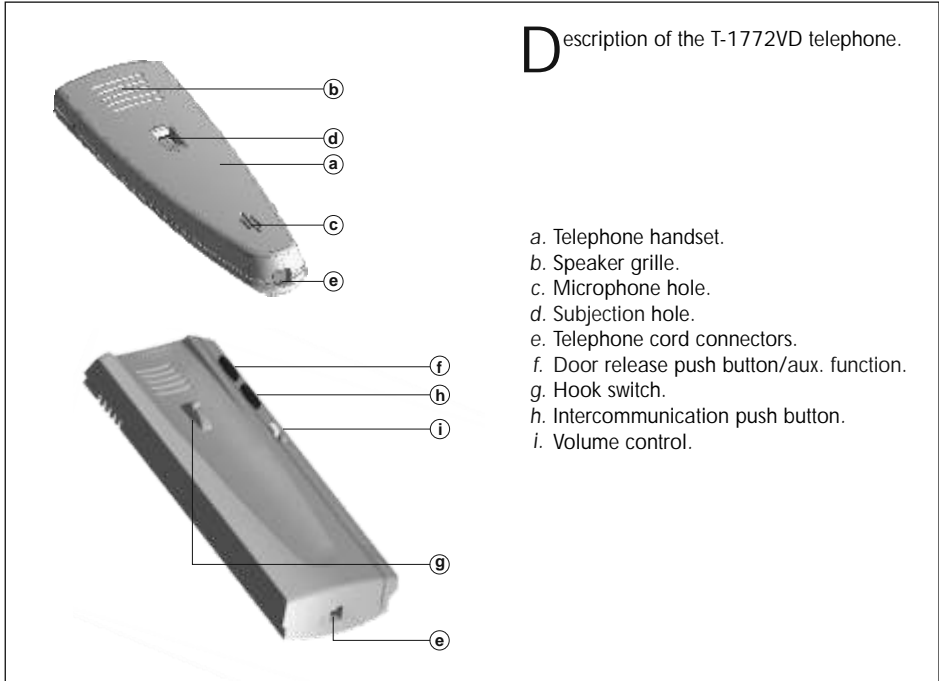

# TELEPHONE DESCRIPTION

## Call volume control.

The telephone allows to regulate the call volume with a maximum, medium and off value. With the help of the switch of three positions placed in the right front of the telephone.

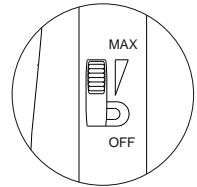

## Configuration jumper 'JP2'.

Only if the door panel has been configured for a system of 2 apartments (see page 33), the JP2 configuration jumper of the telephone, allows to link the telephone of the apartment to a call push button of the door panel. The JP2 jumper is placed inside of the telephone.

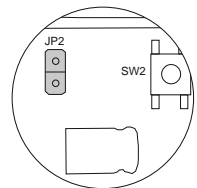

\* JP2  Linked telephone to call push button 1 (apartment 1).  
System of 1 apartment, JP2 must be inserted.

JP2  Linked telephone to call push button 2 (apartment 2).

Call push button (1 apartment):



Call to apartment 1.



Call to apartment 1.

Call push button (2 apartments):



Call to apartment 1.



Call to apartment 2.

**Important:** If the door panel is configured for 1 apartment, the JP2 jumper of the telephone must be inserted.

\*Factory default.

## Intercom function.

The T-1772VD telephone, incorporate as standard the intercommunication function between two units of the same apartment.

To establish an intercom communication lift the handset and press the intercom push button  on the calling telephone: acoustic tones will be reproduced on the handset confirming the call is in progress, the called telephone will receive the call. To establish communication, lift the handset of the called telephone. The communication will last for 90 seconds or until the handset is replaced in any of two telephones. If during an intercom communication a call is made from the door panel, acoustic tones will be heard on the handset of both telephones. To establish communication with the door panel, it must end the intercom and the visitor back to make the call from the door panel.

**F**ix the telephone to the wall.



It is necessary to open the telephone for wiring and fixing purposes. To open the telephone, insert a plain screwdriver into the slots and gently lever as shown in the drawing.

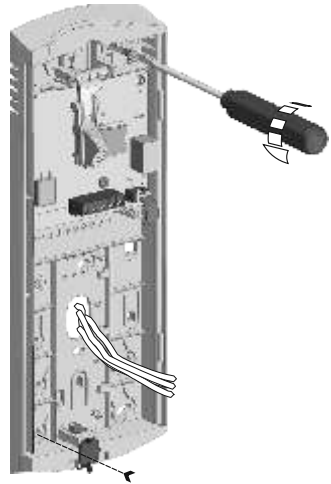

Avoid placing the telephone near sources of heat, in dusty locations or smoky environments. The telephone can be fixed using an electrical embedding box or directly on the wall, as shown on the picture. If the telephone will be installed directly over the wall, drill two holes of  $\text{Ø}6\text{mm}$  on the specified positions, using 6mm wall plugs and  $\text{Ø}3.5 \times 25\text{mm}$  screws.



Pass the installation wires through the corresponding hole and connect them as shown on the installation diagrams. Close the telephone as shown on the picture. Once the telephone is closed, connect the handset using the telephone cord and put it on the cradle.

## Connection to (1 apartment).

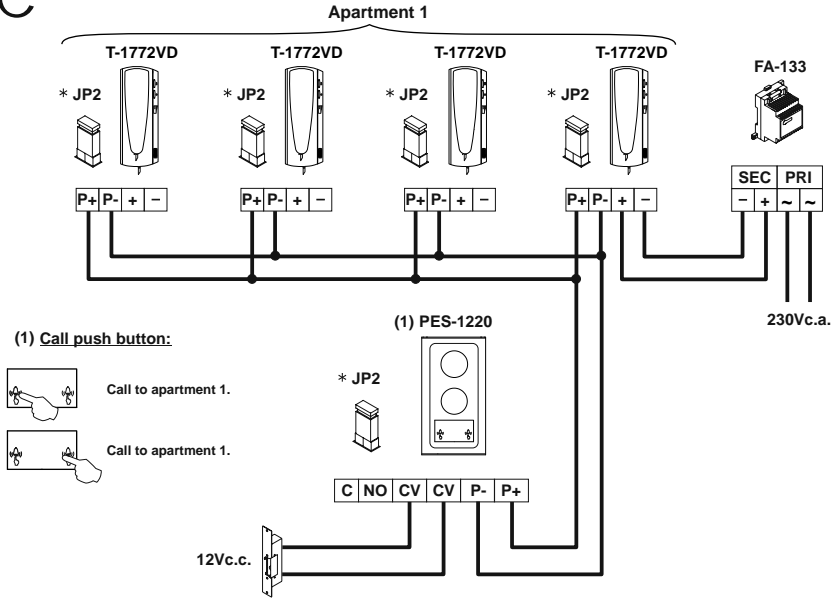

\* IMPORTANT: Configure the JP2 jumper for one or two apartments (see page 33 for the door panel and page 37 for the telephone).

## Connection to (2 apartments).

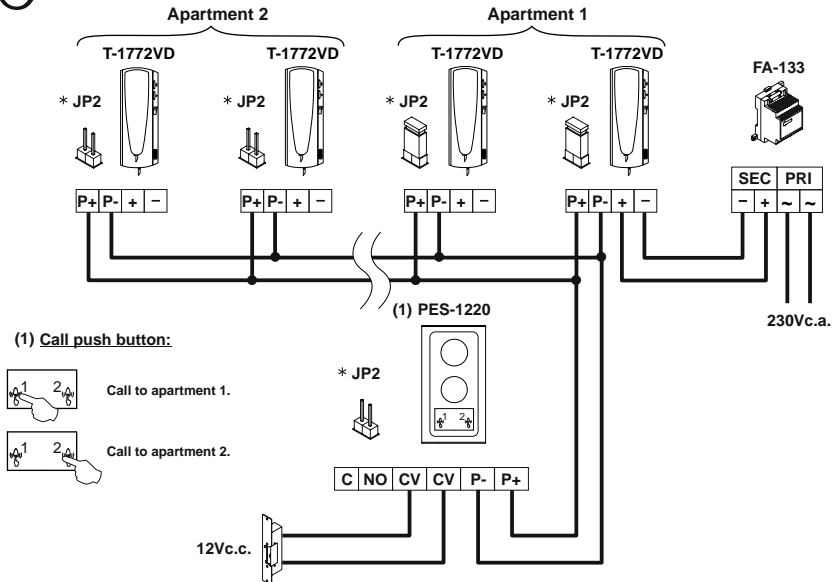

\* IMPORTANT: Configure the JP2 jumper for one or two apartments (see page 33 for the door panel and page 37 for the telephone).

Sections chart.

Terminal	Distance up to		
	20m.	50m.	100m.
P+, P-	1,00mm <sup>2</sup>		1,50mm <sup>2</sup>
+, -	1,50mm <sup>2</sup>	- - - -	
CV, CV	1,50mm <sup>2</sup>	- - - -	

Connection of an a.c. lock release by using TF-104 transformer and SAR-12/24 relay.

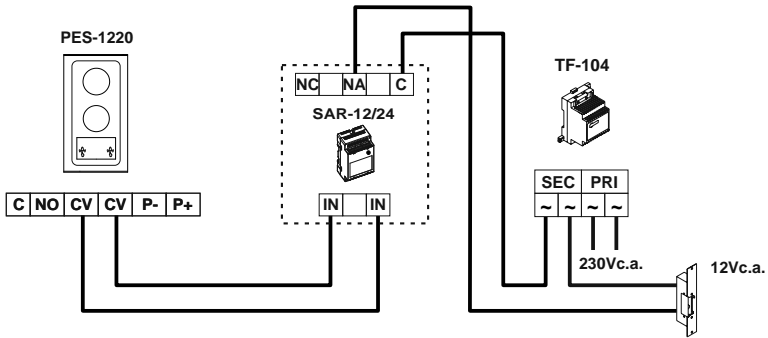

Connection of an auxiliary device or control for gate automation.

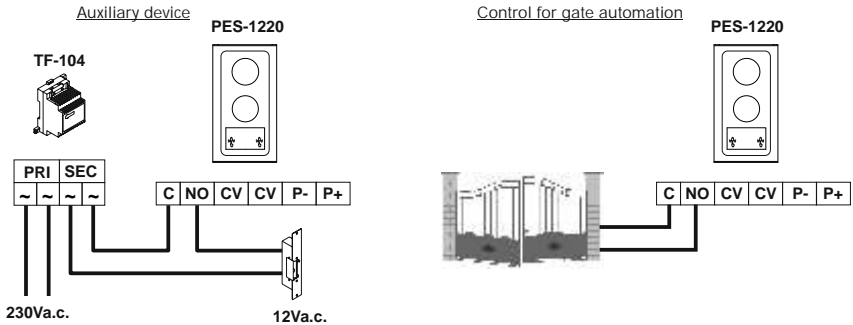

-Use an external relay for devices with higher consumption than 12Vd.c. / 1A.  
 -'C' and 'NO' contact free auxiliary.

- ☞ Nothing operates.
  - ☞ Check the output power supply voltage between '-' and '+' is of 18Vd.c. Otherwise, disconnect the power supply from the installation and measure again. If its correct now, it means there is a short circuit in the installation. Disconnect the power supply from the mains and check the installation.
  - ☞ Check the polarity wiring.
  - ☞ Check the JP2 configuration jumper of the door panel and the telephone/s are properly configured, (see page 33 for the door panel and page 37 for the telephone).
- ☞ Telephone don't receive calls.
  - ☞ Check the output power supply voltage between '-' and '+' is of 18Vd.c. Otherwise, disconnect the power supply from the installation and measure again. If its correct now, it means there is a short circuit in the installation. Disconnect the power supply from the mains and check the installation.
  - ☞ Check the polarity wiring.
  - ☞ Check the JP2 configuration jumper of the door panel and the telephone/s are properly configured, (see page 33 for the door panel and page 37 for the telephone).
- ☞ Inappropriate ring tone volume.
  - ☞ Adjust the telephone call volume, (see page. 37).
- ☞ Inappropriate audio level.
  - ☞ Adjust the audio levels as shown on page 33.
- ☞ Does not work the intercom.
  - ☞ Remember that this function is only possible on installations with more than one telephone.
  - ☞ Check the intercom function steps have been realized correctly, (see page 37).
- ☞ Door open function no operates.
  - ☞ Remember that this function is only available with handset picked up, without call reception or during a process of communication.
  - ☞ Check the lock release and its wiring.



**1141 Budapest, Fogarasi út 77.**      **1095 Budapest, Mester utca 34.**  
Tel.: \*220-7940, 220-7814, 220-7959,      Tel.: \*218-5542, 215-9771, 215-7550,  
220-8881, 364-3428 Fax: 220-7940      216-7017, 216-7018 Fax: 218-5542  
Mobil: 30 531-5454, 30 939-9989      Mobil: 30 940-1970, 20 949-2688

**www.golmar.hu**

**E-mail: info@delton.hu Web: www.delton.hu**