



NHEA GB2 TERMINAL

USER MANUAL



INTRODUCTION

First of all, we thank and congratulate you for purchasing this product.

Our commitment to achieving the satisfaction of customers like you is manifested through our ISO-9001 certification and the manufacture of products like the one you have just purchased.

Its advanced technology and strict quality control will ensure that customers and users enjoy the numerous features that this device offers. To get the most out of them and ensure proper operation from day one, we recommend that you read this instruction manual.

CONTENTS

Introduction.....2

Contents.....2

Safety precautions.....2

Characteristics.....3

System operation.....3

Description of the Nhea terminal.....

 Description.....4

 Function buttons.....4

 Status LED.....4

 Connection terminals.....4

 Audio volume control.....4

 Call volume control.....4

 DIP switch.....5

 Configuration of terminal address codes (up to 32 addresses).....5-6

 Configuration of terminal address codes (up to 128 addresses).....6-9

 Front LED functions.....9

 Setting the ringtones.....10

 Intercom function.....10

 'Do not disturb' mode function.....10

 Light activation function (staircase light).....10

Terminal installation.....

 In wall mounting connector.....11

 In embedding box.....12



Wiring diagrams.....13-14

Notes.....15









SAFETY PRECAUTIONS

- **Always disconnect the power supply** before making modifications to the device.
- The fitting and handling of these devices must be carried out by **authorised personnel**.
- The wiring must run at least **40cm away from any other wiring**.
- Do not overtighten the screws on the connector.
- Install the Nhea terminal in a dry protected location free from the risk of dripping or splashing water.
- Do not place in humid, dusty or smoky locations, or near sources of heat.
- Before connecting the device to the mains, check the connections between the door panel, power supply and Nhea terminals.
- Always follow the instructions contained in this manual.

CHARACTERISTICS

- Nhea hands-free audio terminal with simplified installation (non-polarised 2 wire bus).
- Up to 4 Nhea terminals/monitors per apartment (master, slave 1, slave 2 and slave 3).
- Up to 32 apartments/Nhea terminals per installation.
- Up to 128 apartments/Nhea terminals per installation and maximum 1 Nhea terminal per apartment (**EL632 GB2A/EL642 GB2A sound module required**).
- Completely private conversation.
- Call reception volume control (high and low).
- Audio volume control (high and low).
- Input for calls from the interior door of the apartment.
- Different ringtones to identify the origin of the call (door panel, intercom or apartment door).
- Button  for starting/stopping communication and intercom calls (within the same apartment).
- Button  for lock release 1 activation.
- Button **AUX** for lock release release 2 activation/'do not disturb' mode/ light activation (SAR-GB2 and SAR-12/24 modules required).
- Button  for configuring ringtones.
- Dip switches for setting the terminal address (call code), master/slave and end of line.

SYSTEM OPERATION

- To make a call, the visitor needs to press the button for the apartment, an audible tone indicates that the call is being made and LED  on the door panel illuminates. If vocal synthesis is enabled, a 'Call is in progress' message appears indicating that a call is being made. At this moment, the apartment's terminal(s) receives the call. If another apartment is called by mistake, press the button for the correct apartment and the first call will be cancelled.
- The call lasts for 40 seconds. If the call is not answered within 40 seconds, LED  will turn off and the channel will be freed.
- To establish communication, press button  on any terminal in the apartment and door panel LED  will illuminate.
- Communication will last for one and a half minutes or until button  is pressed again. When communication has finished, LEDs  and  will turn off and the channel will be freed. If vocal synthesis is activated, a 'Communication is finished' message will indicate that the call is over.
- To open the door, press button  (if it exists and, to open the second door, press button **AUX**) during the call or communication processes: one press activates the lock release for five seconds and LED  on the door panel will also illuminate for five seconds. If vocal synthesis is enabled, a 'Door Opened!' message will be indicated on the door panel.
- Description of the function buttons can be found on p. 4.

TERMINAL DESCRIPTION:

Description:

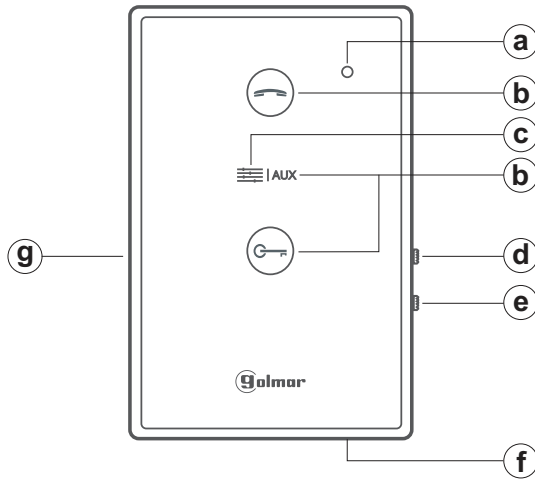

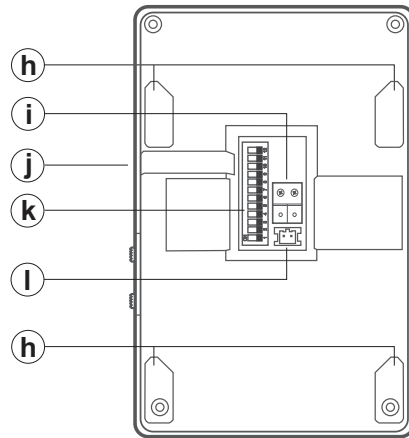

- a. Status LED.
- b. Function push button.
- c. Ringtone settings button.
- d. Audio volume control switch.
- e. Ringtone volume control switch.
- f. Microphone.
- g. Speaker.



- h. Connector fixings.
- i. Bus connection terminals.
- j. Horizontal cable entry.
- k. DIP switch.
- l. Hz connector.

Function push button:

 Start/stop communication button.
In standby: Press for 3 seconds to make an intercom call (same apartment).

 During call reception and communication processes, it enables look release 1 to be activated.

AUX During call reception and communication processes, it enables look release 2 to be activated. In standby: A short press activates the light (SAR-GB2 and SAR-12/24 modules required).

Press for 3 seconds to activate/deactivate 'do not disturb' mode.

 Ringtone settings button.
In standby: Press for 3 seconds to enable the ringtones to be set.

Status LED:

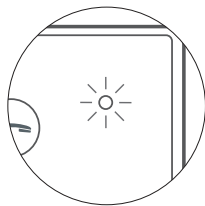

LED off:
Terminal without power.
LED on:
Terminal with power.
Intermittent LED:
Terminal in 'do not disturb' mode.

Description of connection terminals:

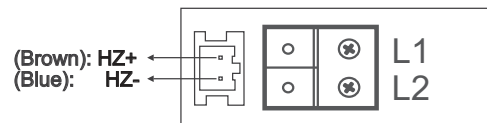

L1, L2: Bus connection
HZ+, HZ-: Door bell connection.

Audio volume control:



The terminal has a communication audio volume control with maximum and minimum volume settings.

Call volume control:

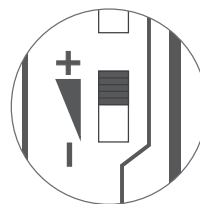

The terminal has a call volume control with maximum and minimum volume settings.

TERMINAL DESCRIPTION:

Description of the DIP switch and configuration of the Nhea terminal address (code):

DIP 1 to DIP 5: Configure the Nhea terminal address (up to 32 addresses).

DIP 1 to DIP 7: With **DIP 10 set to ON**, it enables the Nhea terminal address to be configured (up to 128 addresses).

The switches set to OFF have a zero value.

The values of the switches set to ON are shown in the table below.

The Nhea terminal code is the sum of the values of the switches set to ON.

Table of values (DIP 10 to OFF)

Switch number:	1	2	3	4	5
Value when ON:	1	2	4	8	16

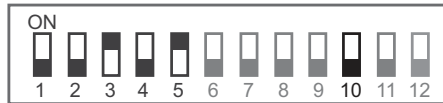

Example: 0 + 0 + 4 + 0 + 16 = 20

Table of values (DIP 10 to ON)

Switch number:	1	2	3	4	5	6	7
Value when ON:	1	2	4	8	16	32	64



Example: 1 + 2 + 4 + 0 + 0 + 0 + 64 = 71

DIP 8 and DIP 9: Set the Nhea terminal as master/slave. DIP 8 and DIP 9 to OFF master, DIP 8 to ON and DIP 9 to OFF slave 1, DIP 8 to OFF and DIP 9 to ON slave 2, DIP 8 and DIP 9 to ON slave 3. **If DIP 10 to ON, the Nhea terminal is always 'master'.**

DIP 10: Leave in the OFF position for installations of up to 32 Nhea terminals (DIP 6 and DIP 7 without function). Set to ON for installations of up to 128 Nhea terminals (**EL632 GB2A/EL642 GB2A sound module required**), DIP 8 and DIP 9 have no function, the Nhea terminal is always 'master' (maximum 1 Nhea terminal per apartment).

DIP 11: Configures the end of line. It should always be set to OFF in installations with only Nhea terminals. In mixed installations with Nhea terminals in the same apartment, set to ON for the terminals in which the BUS cable ends and set to OFF for intermediate terminals.

DIP 12: Leave in the OFF position (no function).

Configuration of Nhea terminal address codes (up to 32 addresses):

DIP 11: Configures the end of line. It should always be set to OFF in installations with only Nhea terminals. In mixed installations with Nhea terminals in the same apartment, set to ON for the terminals in which the BUS cable ends and set to OFF for intermediate terminals.

DIP 11 to OFF



DIP 11 to ON



DIP 1 to DIP 5: To configure the Nhea terminal/apartment address (up to 32 addresses) and **DIP 10 to OFF.**

Apartment code 1 (*)



Apartment code 2



Apartment code 3



Apartment code 4

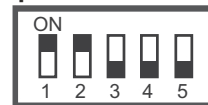

Apartment code 5

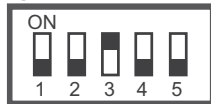

Apartment code 6

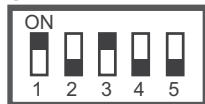

Apartment code 7



Apartment code 8



Apartment code 9



Apartment code 10



Apartment code 11



Apartment code 12



IMPORTANT: In coded panel systems (N3301/GB2), an EL632 GB2A/EL642 GB2A sound module is required and must be configured to 'operating mode 5' (see door panel manual).

(*) -In door panel systems with call buttons, the first address on the Nhea terminal is 'Code 0' (see door panel manual).

-In coded panel systems (N3301/GB2), 'Code 0' is 'Code 32', which means that when a call is made to a Nhea terminal with 'Code 0' (DIP 1 to DIP 5 set to OFF), it needs to be entered (3) (2) (0) on the N3301/GB2 numeric keypad (see door panel manual).

In the software (Address Manager GB2), 'Code 0' is also shown as 'Code 32'.

Continued overleaf

TERMINAL DESCRIPTION:

Continued from previous page.

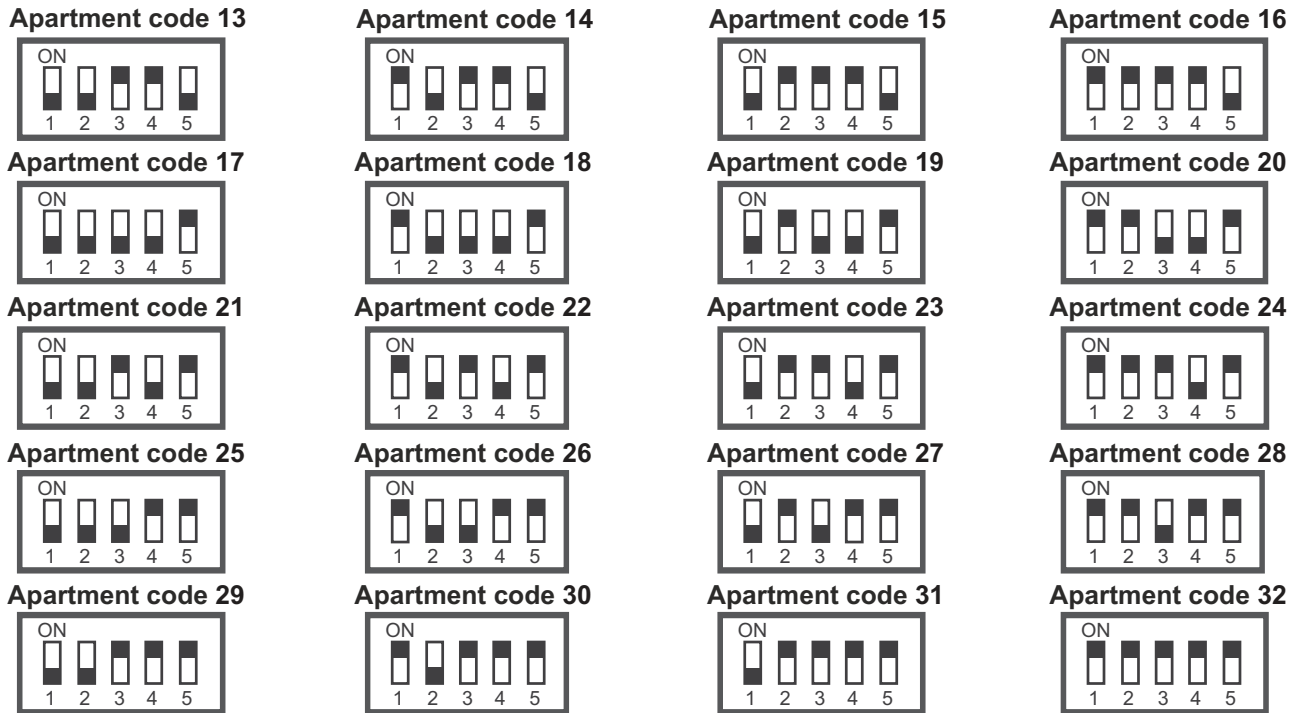

Configuration of Nhea terminal address codes (up to 128 addresses):

Up to 128 apartments/Nhea terminals per 'audio only' installation (**EL632 GB2A/EL642 GB2A sound module required and button panel must be set to 'operating mode 2' or coded panel to 'operating mode 6', see corresponding door panel manual**).

DIP 10: Set to **ON** for 'audio only' installations of up to 128 Nhea terminals.

DIP 11: Configures the end of line. It should always be set to **OFF** in installations with only Nhea terminals.



DIP 1 to DIP 7: To configure the Nhea terminal/apartment address (up to 128 addresses).

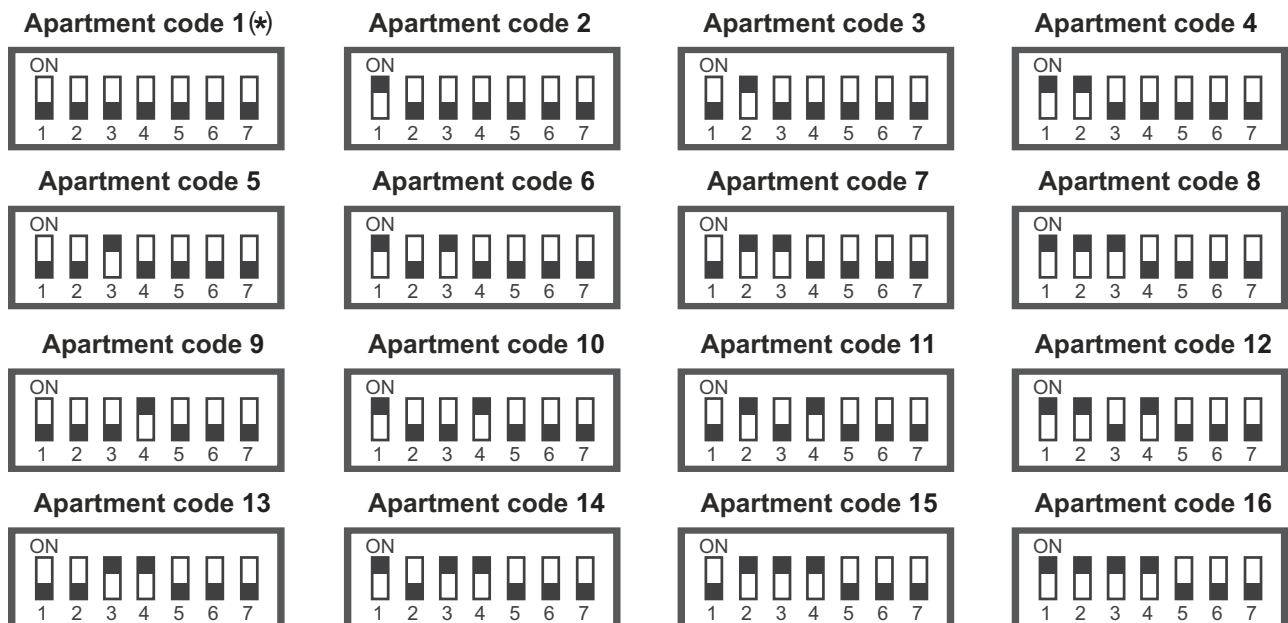

(*) -In door panel systems with call buttons, the first address on the Nhea terminal is 'Code 0' (see door panel manual).











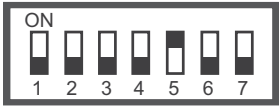
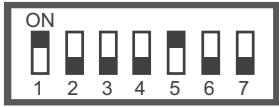
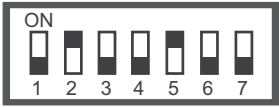
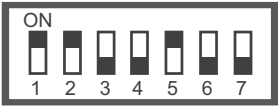





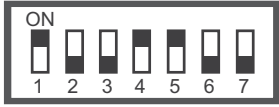























-In coded panel systems (N3301/GB2), 'Code 0' is 'Code 128', which means that when a call is made to an Nhea terminal with 'Code 0' (DIP 1 to DIP 7 set to OFF), it needs to be entered (1)(2)(8) on the N3301/GB2 numeric keypad (see door panel manual).

-In the software (Address Manager GB2), 'Code 0' is also shown as 'Code 128'.

Continued overleaf

TERMINAL DESCRIPTION:





























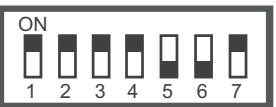











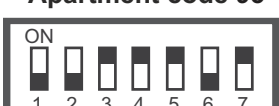

Continued from previous page.

<p>Apartment code 17</p> 	<p>Apartment code 18</p> 	<p>Apartment code 19</p> 	<p>Apartment code 20</p> 
<p>Apartment code 21</p> 	<p>Apartment code 22</p> 	<p>Apartment code 23</p> 	<p>Apartment code 24</p> 
<p>Apartment code 25</p> 	<p>Apartment code 26</p> 	<p>Apartment code 27</p> 	<p>Apartment code 28</p> 
<p>Apartment code 29</p> 	<p>Apartment code 30</p> 	<p>Apartment code 31</p> 	<p>Apartment code 32</p> 
<p>Apartment code 33</p> 	<p>Apartment code 34</p> 	<p>Apartment code 35</p> 	<p>Apartment code 36</p> 
<p>Apartment code 37</p> 	<p>Apartment code 38</p> 	<p>Apartment code 39</p> 	<p>Apartment code 40</p> 
<p>Apartment code 41</p> 	<p>Apartment code 42</p> 	<p>Apartment code 43</p> 	<p>Apartment code 44</p> 
<p>Apartment code 45</p> 	<p>Apartment code 46</p> 	<p>Apartment code 47</p> 	<p>Apartment code 48</p> 
<p>Apartment code 49</p> 	<p>Apartment code 50</p> 	<p>Apartment code 51</p> 	<p>Apartment code 52</p> 
<p>Apartment code 53</p> 	<p>Apartment code 54</p> 	<p>Apartment code 55</p> 	<p>Apartment code 56</p> 
<p>Apartment code 57</p> 	<p>Apartment code 58</p> 	<p>Apartment code 59</p> 	<p>Apartment code 60</p> 

Continued overleaf

TERMINAL DESCRIPTION:

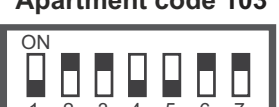
Continued from previous page.

Apartment code 61 	Apartment code 62 	Apartment code 63 	Apartment code 64 
Apartment code 65 	Apartment code 66 	Apartment code 67 	Apartment code 68 
Apartment code 69 	Apartment code 70 	Apartment code 71 	Apartment code 72 
Apartment code 73 	Apartment code 74 	Apartment code 75 	Apartment code 76 
Apartment code 77 	Apartment code 78 	Apartment code 79 	Apartment code 80 
Apartment code 81 	Apartment code 82 	Apartment code 83 	Apartment code 84 
Apartment code 85 	Apartment code 86 	Apartment code 87 	Apartment code 88 
Apartment code 89 	Apartment code 90 	Apartment code 91 	Apartment code 92 
Apartment code 93 	Apartment code 94 	Apartment code 95 	Apartment code 96 
Apartment code 97 	Apartment code 98 	Apartment code 99 	Apartment code 100 
Apartment code 101 	Apartment code 102 	Apartment code 103 	Apartment code 104 



Continued overleaf

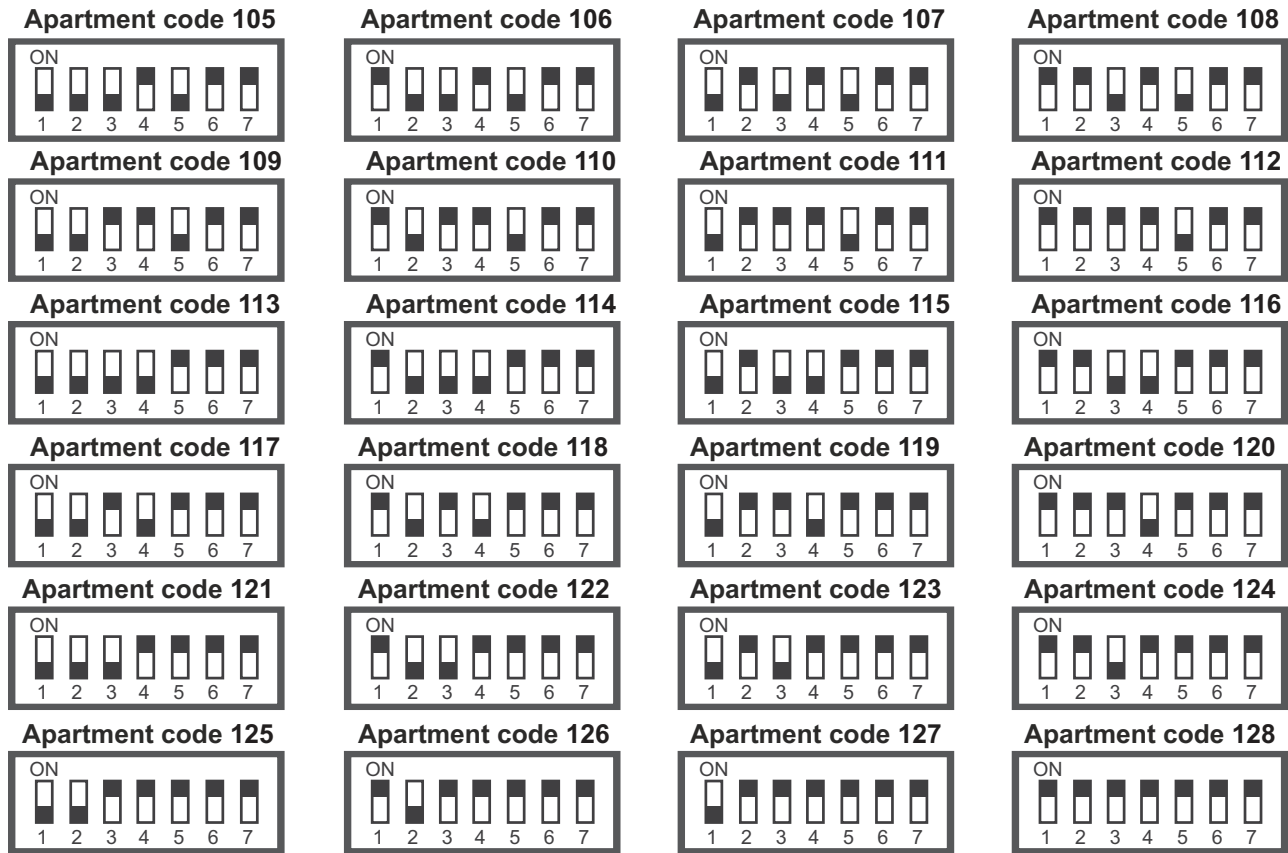

TERMINAL DESCRIPTION:

Continued from previous page.



Description of front LED functions:

The Nhea GB2 terminal has a status LED, and LEDs on function buttons  and  to indicate the status of the terminal.

	LED 	LED 	STATUS LED
Standby (no power)	OFF	OFF	OFF
Standby (with power)	OFF	OFF	ON
'Do not disturb' mode activated	OFF	OFF	Blinking
Call from door panel (ringtone in terminal)	Rapid blink	ON	ON
Communication with door panel	Slow blink	ON	ON
Call from terminal (ringtone in terminal)	Rapid blink	ON	ON
Communication with terminal	Slow blink	ON	ON
Ringtone settings mode	Slow blink	Slow blink	ON Blinking
Call from apartment door (ringtone in terminal)	OFF	OFF	ON



TERMINAL DESCRIPTION:**Setting the ringtones:****Description:**

To change the terminal's ringtones (door panel, intercom and apartment door), press settings button .

There are three ringtone selection groups and each consists of three fixed tones. The first tone of each group heard during selection corresponds to door panel calls, the second to intercom calls and the third to apartment door calls.

Setting and selecting the ringtone group:

The terminal must be in standby to set and select the ringtone group.

To change the ringtones, press button  for 3 seconds. The LEDs on buttons  and  will blink to indicate that the terminal is in settings mode.

To change the ringtone group, press the configuration button  until the required ringtone group can be heard (up to 3 ringtone groups available in carousel mode).



To exit and save the selected ringtone group, press button  and the LEDs on buttons  and  will turn off. The terminal exits settings mode after 7 seconds of inactivity and saves the last ringtone group selected.

Make a call to check that the correct ringtone group has been selected.

Intercom function:

Intercom functionality between two points in the same apartment comes as standard with the Nhea GB2 terminal.

The terminal must be in standby to make intercom calls.

To make an intercom call, press button  for 3 seconds. The LED on button  will blink, the LED on button  will light up and the terminal(s) being called in the apartment will ring to confirm that the call is being made.

The call needs to be answered within 40 seconds.

To establish communication, press button  on the terminal called (or one of the terminals called if there is more than one slave terminal).

Communication will last for one and a half minutes or until button  is pressed again.

'Do not disturb' mode function:

The terminal must be in standby to activate/deactivate 'Do not disturb' mode.

To activate 'Do not disturb' mode, press button **AUX** for 3 seconds. The terminal's status LED will then blink to indicate that the function is activated. The terminal will not receive door panel, intercom or apartment door calls.

More than one terminal in the same apartment: Activating do not disturb mode in the master terminal will not allow calls from the door panel to be received in the apartment. If do not disturb mode is activated in a slave terminal (not in the master terminal), it will allow calls from the door panel to be received in the apartment except in the slave terminal with do not disturb mode activated.

To deactivate do not disturb mode, press button **AUX** for 3 seconds. The terminal's status LED will then light up to indicate that the function is deactivated. The terminal will now receive door panel, intercom and apartment door calls.

Light activation function:

The terminal must be in standby for light activation (SAR-GB2 and SAR-12/24 modules required).

For light activation (e.g. 'staircase light'), press button **AUX**.

Important: For connections and configuration, see the TSAR-GB2 and TSAR-12/24 manuals.

INSTALLING THE TERMINAL IN A WALL MOUNTING CONNECTOR

Avoid dusty or smoky environments or locations near sources of heat.

Positioning the wall mounting connector:

The top of the wall mounting connector should be located at a height of 1.60m from the ground. The minimum distance between the wall mounting connector and the closest object must be 5 cm.

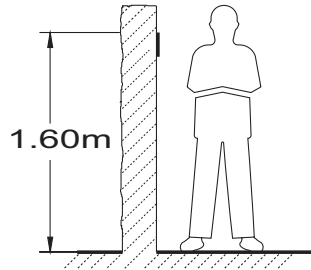

Fixing the terminal's wall mounting connector to the wall:

Fix the terminal's wall mounting connector to the wall by drilling two 6mm diameter holes and using the screws and plugs supplied with the terminal.

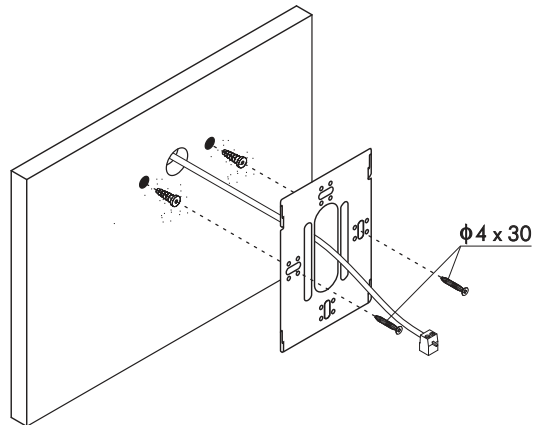

Positioning the terminal:

Connect the cables to the terminal (see p. 4), position the terminal in front of the wall mounting connector, ensuring that the holes in the base of the terminal line up with those on the connector ①, and then move the terminal downwards ② until the terminal is securely fixed to the connector ③.

Remember to remove the protective covering from the front of the terminal once installation has been completed.

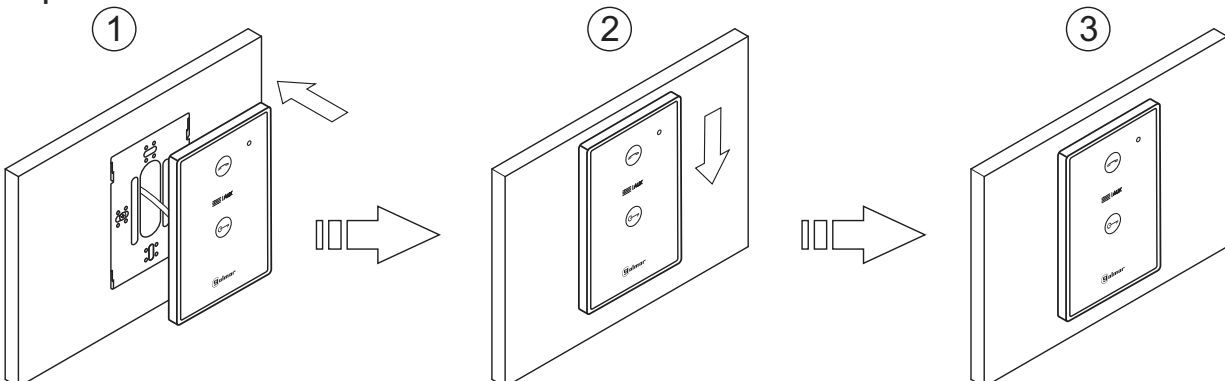

INSTALLATION OF THE TERMINAL IN AN EMBEDDING BOX

Avoid dusty or smoky environments or locations near sources of heat.

Positioning the embedding box:

Make a hole in the wall to position the top of the universal embedding box at a height of 1.60 m from the ground. The minimum distance between the sides of the embedding box and the closest object must be 5 cm.

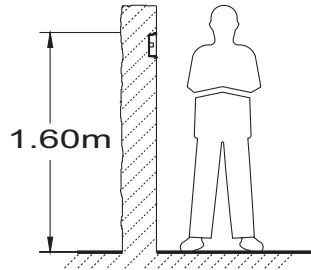

Positioning the embedding box and fitting the wall mounting connector:

Pass the cable through the hole made in the embedding box. Embed the box and ensure that it is level and flush. Fix the wall mounting connector of the terminal to the embedding box with the screws supplied.

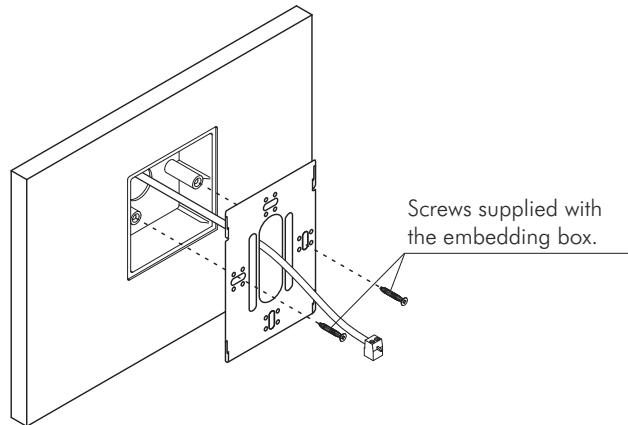

Positioning the terminal:

Connect the cables to the terminal (see p. 4), position the terminal in front of the wall mounting connector, ensuring that the holes in the base of the terminal line up with those on the connector ①, and then move the terminal downwards ② until the terminal is securely fixed to the connector ③.

Remember to remove the protective covering from the front of the terminal once installation has been completed.

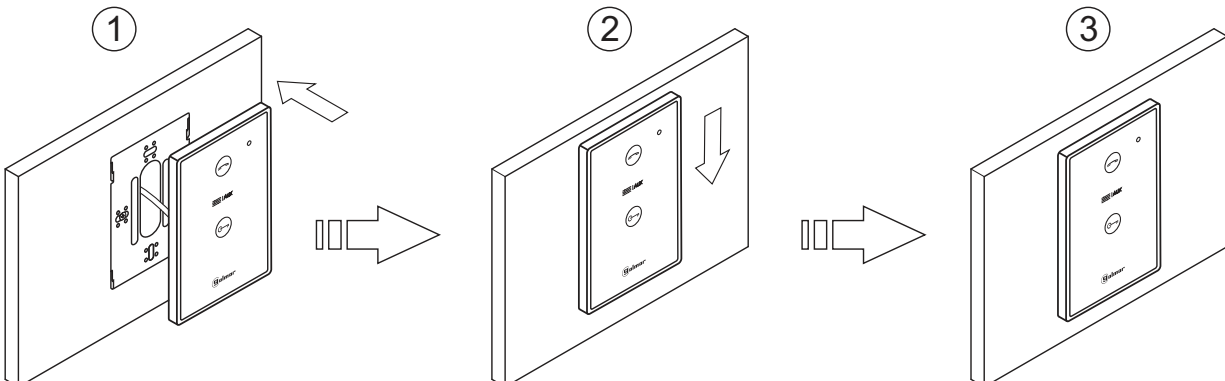

WIRING DIAGRAMS

Installation with 32 apartments/NHEA GB2 terminals and Golmar DC lock release:

(*) IMPORTANT:

With a coded panel system:

- EL632 GB2A/EL642 GB2A sound module is required and must be set to 'operating mode 5'.

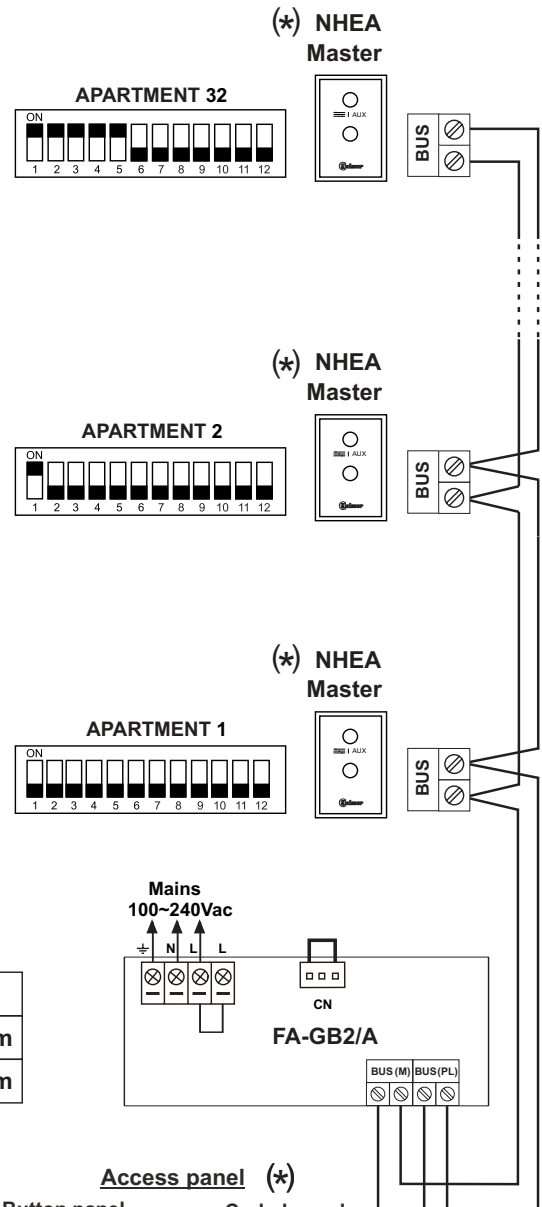

Distances and cross-sections:

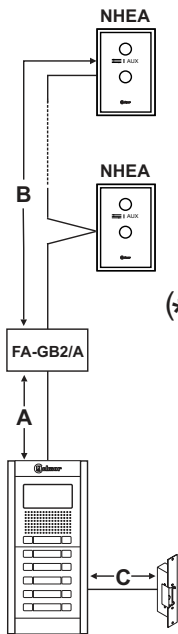

Cable	A	B	C
Twisted pair 2x0.75mm ²	60m	60m	10m
Twisted pair 2x1mm ²	80m	80m	15m

(*) IMPORTANT: Set the DIP switches as shown in the diagram.

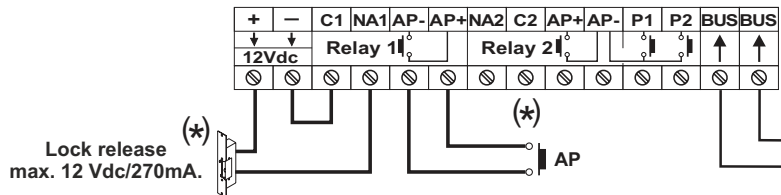
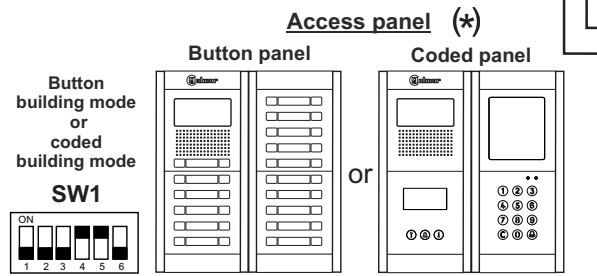

(*) For more information about the door panel, installation, configuration, connection of an AC lock release, 2nd lock release or mixed installation with monitors and Nhea terminals, see the corresponding door panel manual.

WIRING DIAGRAMS

Audio door entry system with 128 apartments/NHEA GB2 terminals and Golmar DC lock release:

IMPORTANT:

- (*) - Up to 128 apartments/Nhea terminals per 'audio only' installation:
EI632 GB2A/EL642 GB2A sound module required and button panel must be set to 'operating mode 2' or coded panel to 'operating mode 6'.
- (1) - The Nhea terminal's DIP 10 should be set to ON.

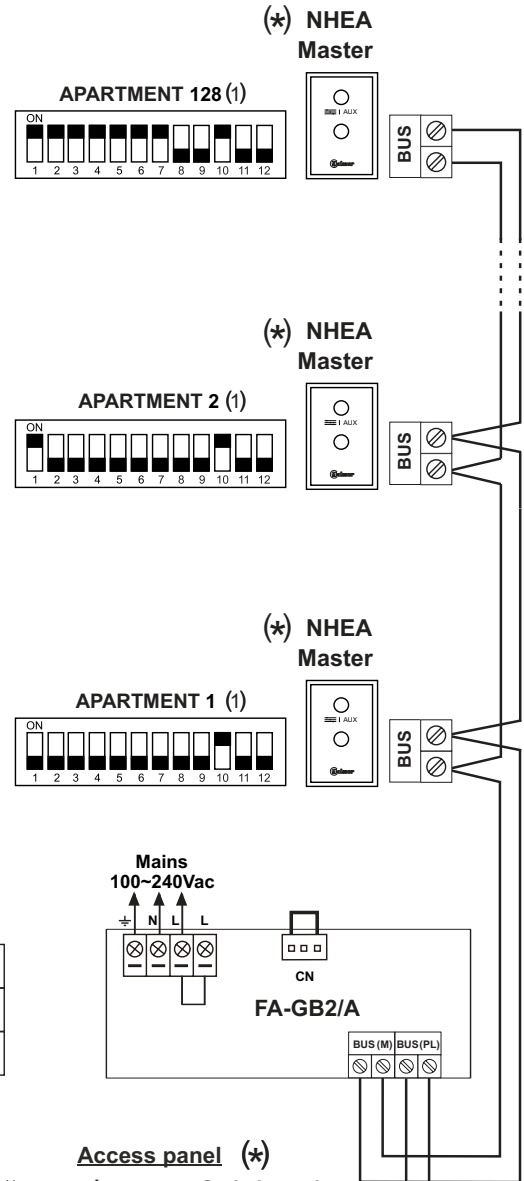

Distances and cross-sections:

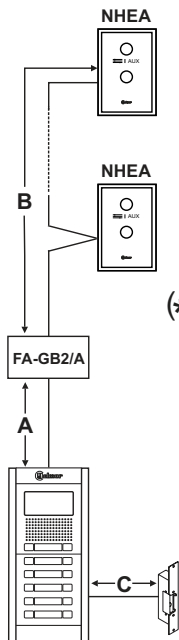

Cable	A	B	C
Twisted pair 2x0.75mm ²	60m	60m	10m
Twisted pair 2x1mm ²	80m	80m	15m

(*) **IMPORTANT:** Set the DIP switches as shown in the diagram.

Telephone only button mode or telephone only coded mode

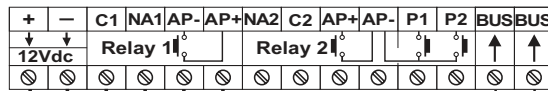
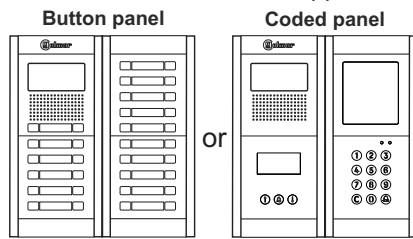
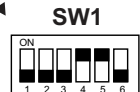

Lock release max. 12 Vdc/270mA.

(*) For more information about the door panel, installation, configuration, connection of an AC lock release, 2nd lock release or mixed installation with monitors and Nhea terminals, see the corresponding door panel manual.



1141 Budapest, Fogarasi út 77. 1095 Budapest, Mester utca 34.
Tel.: *220-7940, 220-7814, 220-7959, Tel.: *218-5542, 215-9771, 215-7550,
220-8881, 364-3428 Fax: 220-7940 216-7017, 216-7018 Fax: 218-5542
Mobil: 30 531-5454, 30 939-9989 Mobil: 30 940-1970, 30 959-0930

www.golmar.hu

E-mail: info@delton.hu Web: www.delton.hu