

Multi Photoelectric Beam Detector

MPB-30D4

Thank you for purchasing SASO Multi Photoelectric Beam Detector. SASO MPB-30D4 will provide reliable service for a long term when properly installed. Please read the following instructions very carefully for accurate and effective use.

Note: SASO MPB-30D4 is designed to detect an intruder and to sound an alarm when detected; it is not to prevent burglary.

We are not responsible for damage or losses from accident, theft, natural calamity, misuse, abnormal use, improper installation and bad maintenance.

1. Precautions on Installation

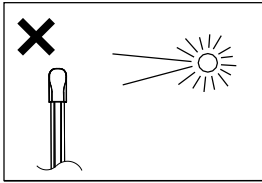

Do not install the unit where exposed to direct sunlight.

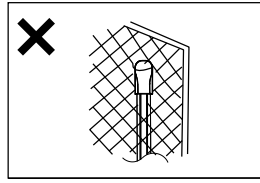

Do not install in a place where it cannot be fixed stably.

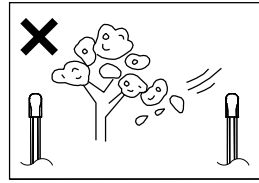

Do not install in places where obstructions are laid within detection range.

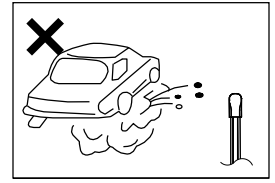

Do not install in places where dirt can be put on the unit.

2. Parts Description

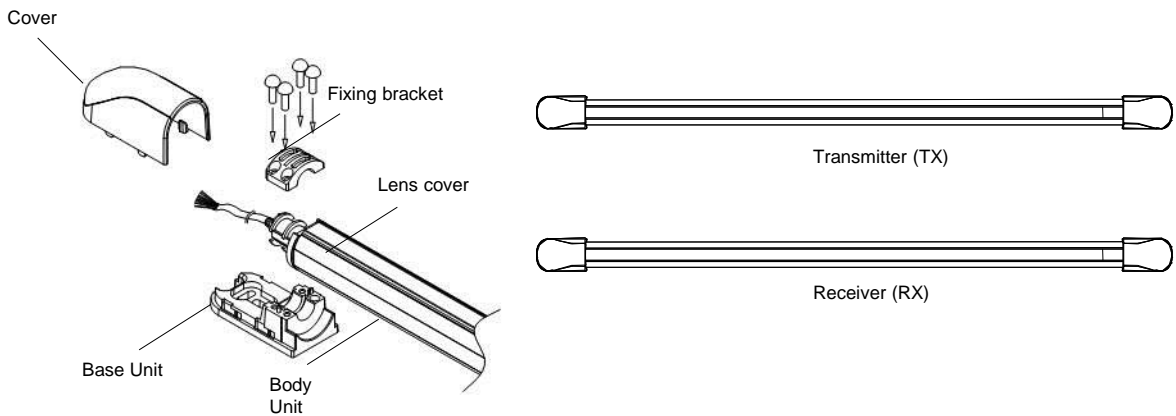

3. Installation

① Fix the base unit with screw bolts on the wall.

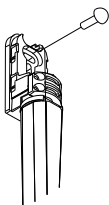

② Connect wires to the terminal. (Refer to 7. WIRING)

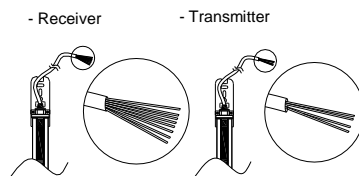

③ After angle adjustment, fix the masking seat to the body unit by tightening screw bolts. (Refer to 6. Angle Adjustment)

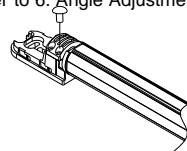

④ Put on the cover.

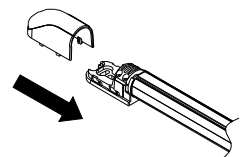

4. Response Time Adjustment (Auto)

2 Beams blocked : 300m/sec

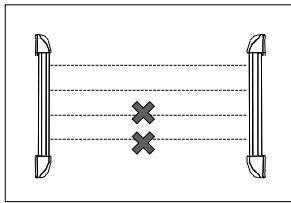

3 Beams blocked : 100m/sec

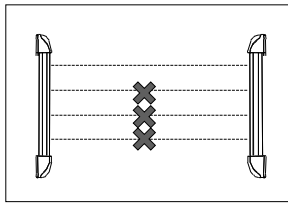

4 Beams blocked : 100m/sec

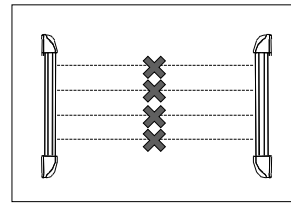

※ MPB Series has automatic response time adjustment according to the number of beams.

5. Application

※ Window

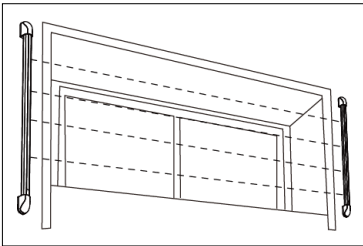

※ Front Door and Outside

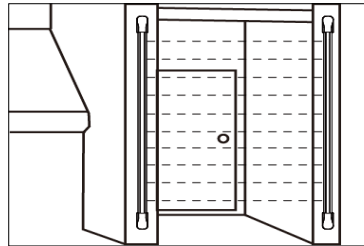

※ Balcony

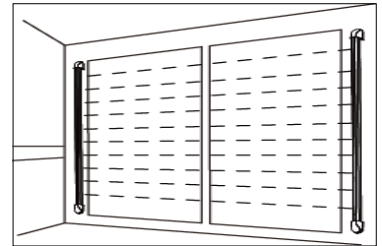

※ Examples of Installation in Different Positions

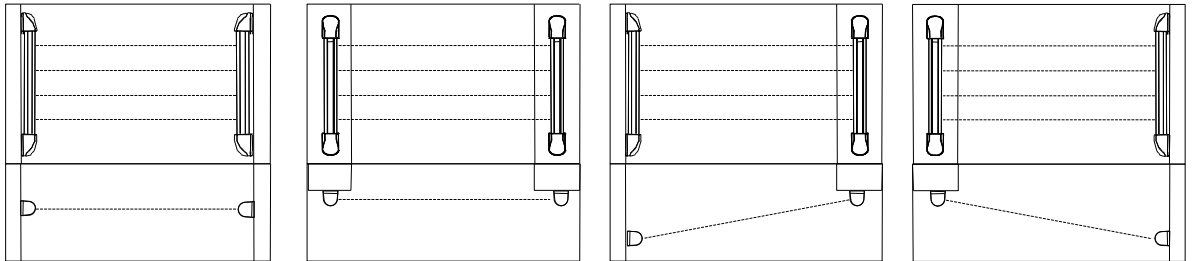

6. Angle Adjustment

- ① Connect to electrical power source.
- ② Align the lens of transmitter and receiver.
- ③ Check LED on receiver and then check lighting / blinking / blackout for each beam.

- Receiver

Beam No.1 LED(blue) — ● — Beam No.2 LED(blue)

Beam No.3 LED(blue) — ● — Beam No.4 LED(blue)

ALRAM LED(red) — ●

- Transmitter

Power LED (Green) — ●

Status	Condition
Good	Corresponding Blue LED Off
Readjust	Corresponding Blue LED Blinks
Alarm	Red & blue LED On

Status	Condition
Power On	Green LED On

* Green LED lighting when transmitter is turned on/ Green LED blackout when transmitter is turned off.

7. Wiring

- Receiver

NO	Color	Polarity	NO	Color	Polarity
1	Red	+	5	Blue	COM
2	Black	-	6	Yellow	N.C
3	White	+	7	Brown	N.O
4	Green	-	8	Orange(Gray)	N.O

- Transmitter

NO	Color	Polarity
1	Red	+
2	Black	-
3	White	+
4	Green	-

- Available Wiring Distance (Based on 1 Set and DC12V)

Wiring size	Voltage	4 beams
AWG 22(Dia 0.65mm)		260m
AWG 20(Dia 0.8mm)		400m
AWG 18(Dia 1.0mm)		630m
AWG 16(Dia 1.1mm)		900m

Note:

1) Maximum wiring distance when two or more sets are connected is the value above divided by the numbers of sets.

2) The signal line can be wired to distance of up to 1,000m with AWG22 telephone line..

- Examples of Wiring

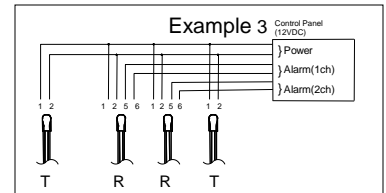
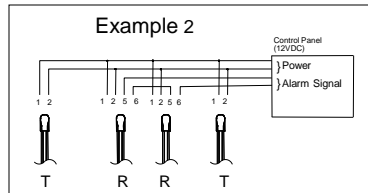
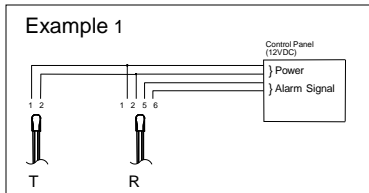

8. Troubleshooting

Problem	Possible Cause	Possible Solution
Inactive Green LED	- Electrical power is cut off.	- Supply electrical power.
	- Inferior wire or wire disconnected.	- Check wiring.
Inactive LED when beam is blocked	- Electrical power is cut off.	- Supply electrical power.
	- Inferior wire or wire disconnected.	- Check wiring.
	- Beam of transmitter is reflected on other objects and goes into the receiver.	- Remove the object or change the direction of beam.
Blue LED is keep lighting	- Improper beam adjustment	- Readjust the angle.
	- There is an object between TX and RX.	- Remove the object between TX and RX.
	- Lens is covered with substance or stain.	- Remove substance or stain with soft cloth.
Periodic False Alarm	- Wiring is improper.	- Check wiring.
	- Electric pressure is improperly supplied.	-Supply stable electric pressure.
	- There is an object between TX and RX .	- Remove the object between TX and RX.
	-Installed in places near noisy machineries.	- Change location for installation.
	- Installed in places where fixation is not stable.	- Install at stable positions.
	- Lens is covered with substance or stain.	- Remove substance or stain with soft cloth.
- Improper beam adjustments	- Readjust the angle.	

9. Specifications

Model	MPB-30D4	
Detection Range	Indoor, Outdoor : 15m	
Number of Beams	4	
Supply Voltage	DC 10 ~ 25V (Polarity)	
Current	120mA	
LED Signals	TX	Power ON: Green LED ON
	RX	Angle Good: Green LED OFF, Readjustment : Green LED Blink, Alarm : Green/Red LED ON
Response Time	100ms / 300ms	
Alarm Output	Dry contact relay output 1C, Contact action: 2±0.5 sec, Contact capacity: 30V(AC/DC) 1A or less	
Temperature	-20°C ~ +60°C	
Beam Adjustment	190° (±95°) right/left	
Mounting Site	Outdoor, indoor wall or window frame (Town house, apartment complex, luxury villa etc.)	
Weight (g)	TX : 478g RX : 488g	
Dimensions (mm)	H832 x W34 x D35	
Materials	Aluminum, PC resin, ASA resin	

* Caution: Above specification is subject to change without prior notice for improvement.

10. External Dimensions

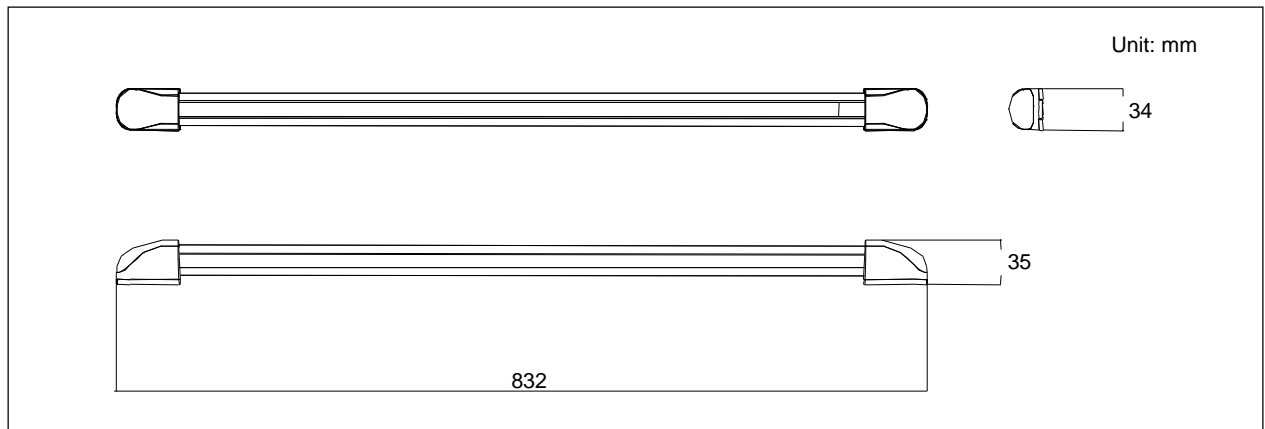

Delton

1141 Budapest, Fogarasi út 77. 1095 Budapest, Mester utca 34.
 Tel.: *220-7940, 220-7814, 220-7959, Tel.: *218-5542, 215-9771, 215-7550,
 220-8881, 364-3428 Fax: 220-7940 216-7017, 216-7018 Fax: 218-5542
 Mobil: 30 531-5454, 30 939-9989 Mobil: 30 940-1970, 20 949-2688

E-mail: delton@delton.hu Web: www.delton.hu

www.saso.hu