

**Passive Infrared Detector
PA-4510P**

Notice : This detector is designed to detect an intruder and to sound alarm when detected; it is not to prevent burglary. We are not responsible for damage or losses from accident, theft, natural calamity, misuse, abnormal use, improper installation and bad maintenance.

1. Parts Description & Coverage and Range

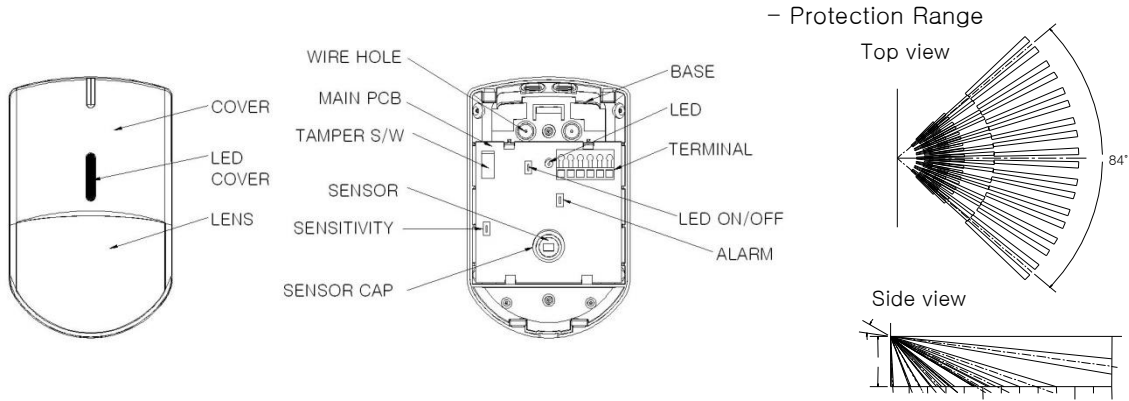

2. Cautions on Installation

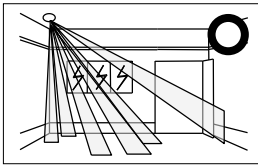

Please install the detector in the desirable detection site.

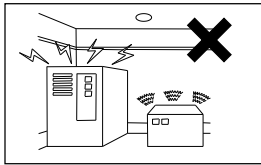

Please avoid installing it where electric noise and vibration is prevalent.

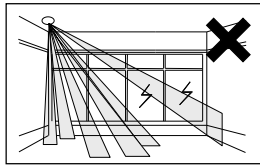

Please avoid direct sunlight to the detector.

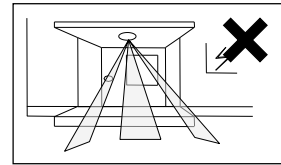

Avoid installing it at outdoor. (indoor only)

3. Installation

1) Separate the cover from body

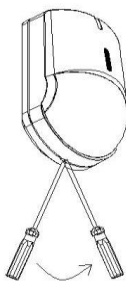

2) Fix it where you want to.

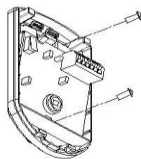

3) Connect wires correctly to the plate of terminal.

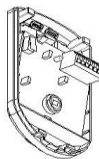

4) Close the body cover.

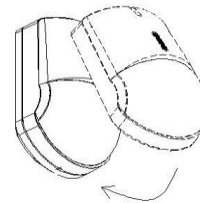

4. Wiring

- TERMINAL

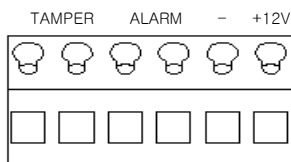

- LED(ON/OFF)

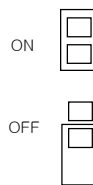

- ALARM(CONTACT)

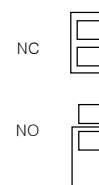

※ CAUTION
Do not connect power to alarm terminal

– Sensitivity Adjustment

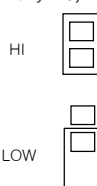

<Sensitivity Adjustment>

- ▶ H (High Sensitivity) : For more sensitive detection
- ▶ L (Low Sensitivity) : For less sensitive detection

※ Notice : This sensor is for indoor use only. Please do not install it in outdoor

※ Respective angels and detection distance when using optional bracket (B-4001)

Installation Height (2.5m)	Detection Distance (m)			
	3m	5m	7m	10m
Angle	20°	10°	5°	0°

5. Troubleshooting

Problem0	Cause	Solution
When LED is not turned on,	Lines of electricity source are cut.	Check the lines
	Electricity source is not correct.	Check it to DC 8 ~ 18V
No contact point although it is set	Cutting lines or abnormality of inner circuit	Check the lines of connection
No contact point when detected	Cutting lines or abnormality of inner circuit	Check the lines of connection
LED is not working when detected	Cutting lines, LED broken down or abnormality of inner circuit.	Check the lines of connection
When there is abnormal working	There is dirt on the cover	Remove dirt with soft cloth
	When it is exposed to direct ray of light	Install it to another place or block the light
	When it can't detect normally	Adjust the scope of alert

6. Specification & Dimension

Model No.	PA-4510P (PET Type)
Detection	Passive Infrared motion detecting
Detection Range	Stereoscopic alert / alert distance : 10m / 84°
Zone Composition	37 Pairs (74 Zone)
Voltage	DC 8 ~ 18V (Polarity)
Current	20mA (MAX)
Alarm Output	Non-voltage contact (N.C / N.O) Contact Volume: AC/DC 30V 0.2A Max Protection Resistance : 18Ω
Alarm LED (RED)	LED On when warming up / LED off when setting / LED on when detecting
Tamper Output	Non-voltage contact output (N.C) Contact Volume: AC/DC 30V 0.2A Max
Temperature	-20°C ~ 60°C
Installation Site	Indoor
PET Function	Under 10kg
Material	COVER, BASE: ABS Resin, LENS: PE Resin
Dimension	102 x 64 x 47mm
Weight	68g

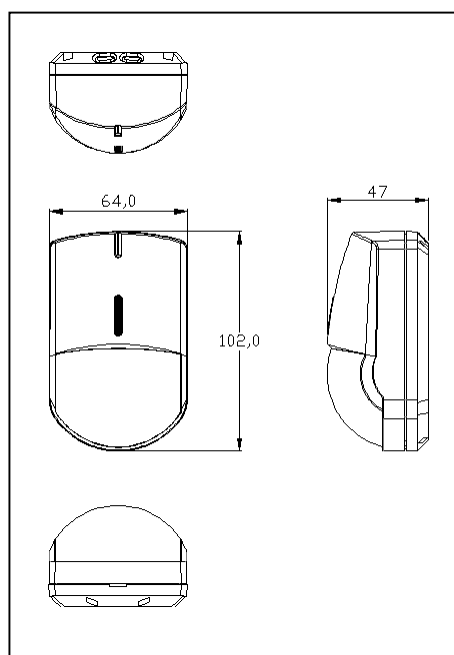

Delton

1141 Budapest, Fogarasi út 77. 1095 Budapest, Mester utca 34.
Tel.: *220-7940, 220-7814, 220-7959, Tel.: *218-5542, 215-9771, 215-7550,
220-8881, 364-3428 Fax: 220-7940 216-7017, 216-7018 Fax: 218-5542
Mobil: 30 531-5454, 30 939-9989 Mobil: 30 940-1970, 20 949-2688

E-mail: delton@delton.hu Web: www.delton.hu

www.saso.hu